

F11 Series

☑ CHF11-R423.22M75K-NB

Pb Free

RoHS Compliant 2002/95/EC

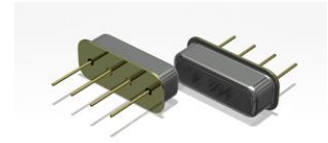

※ Application & Features

- RF, Wireless
- Automotive Equipment at Other
- 11.0×4.5×3.2mm Metal Package
- This specification shall cover the characteristics of 1-port SAW resonator with 423.220M used for remote-control security.

※ Maximum Rating

Rating		Value	Unit
CW RF power dissipation	P	10	dBm
DC voltage between any terminals	V_{DC}	±30	V
Operating temperature range	T_A	-40 ~ +85	°C
Storage temperature range	T_{stg}	-40 ~ +85	°C

※ Electronic Characteristics

Characteristic		Sym	Minimum	Typical	Maximum	Unit
Center Frequency (+25°C)	Absolute Frequency	f_c	423.145	423.220	423.295	MHz
	Tolerance from 423.220 MHz	Δf_c		±75		kHz
Insertion Loss		IL		1.1	1.6	dB
Quality Factor	Unloaded Q	Q_U		14.292		
	50 Ω Loaded Q	Q_L	1000	1700		
Temperature Stability	Turnover Temperature	T_0	25	40	55	°C
	Turnover Frequency	f_0		$f_0 \pm 2.7$		kHz
	Frequency Temperature Coefficient	FTC		0.032		ppm/°C ²
Frequency Aging	Absolute Value during the First Year	$ f_A $		≤10		ppm/yr
DC Insulation Resistance Between Any Two Terminals			1.0			MΩ
RF Equivalent RLC Model	Motional Resistance	R_M		13.5	20	Ω
	Motional Inductance	L_M		72.597		μH
	Motional Capacitance	C_M		1.950		pF
	Shunt Static Capacitance	C_0	2.3	2.6	2.9	pF

※ Mechanical Dimensions and Marking

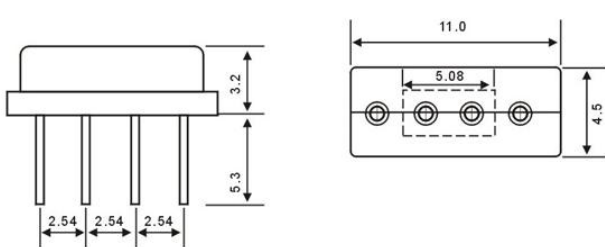
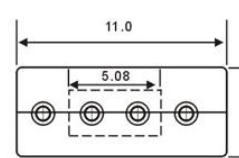
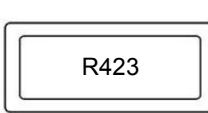
UNIT: mm	
1	Input
4	Output
2,3	Ground

※ Typical Frequency Response

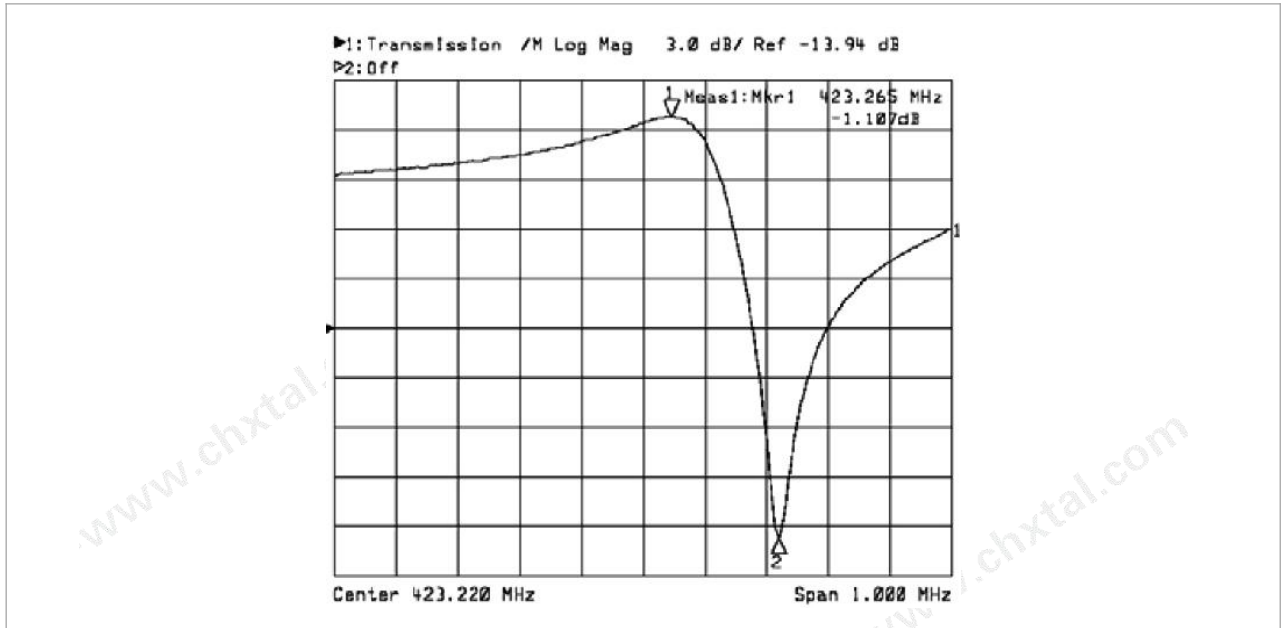

※ Equivalent LC Model

※ Test Circuit

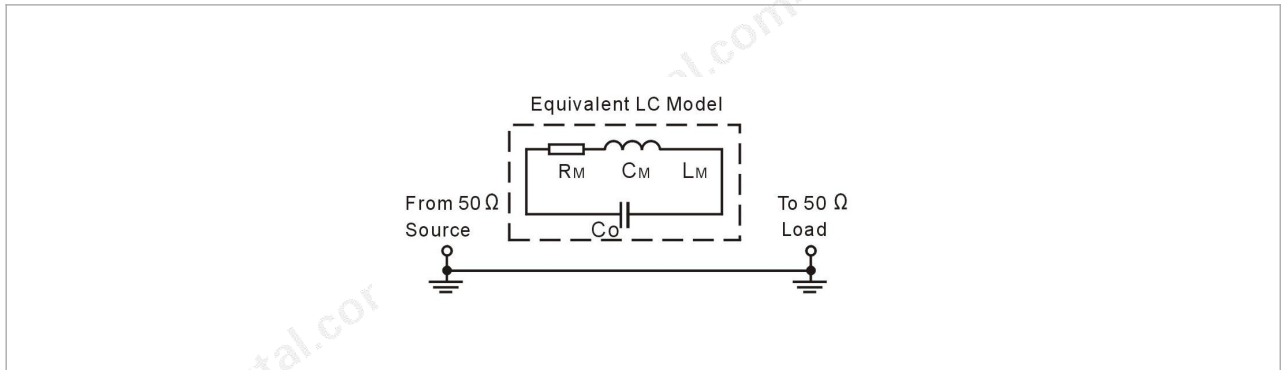

※ Typical Application Circuits

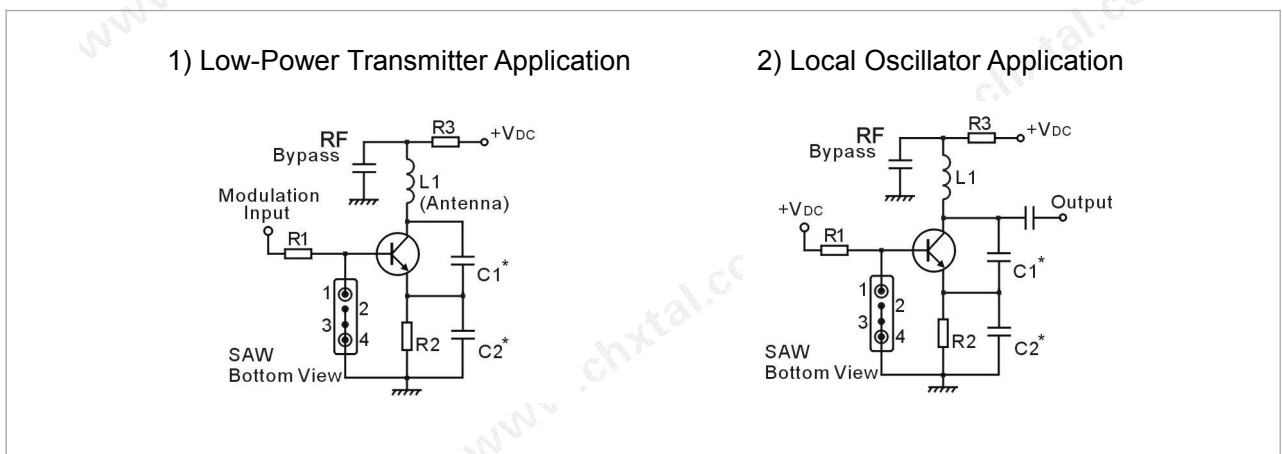

※ Environment Characteristic

1 Thermal Shock:

The components shall remain within the electrical specifications after being kept at the condition of heat cycle conditions: TA=-40℃±3℃, TB=85℃±2℃, t1=t2=30min, switch time≤3min& cycle time : 100 times, recovery time: 2h±0.5h.

2 Resistance to solder heat

Submerge the device terminals into the solder bath at 260℃ ±5℃ for 10±1 sec. Then release the device into the room conditions for 4 hours. It shall meet the specifications in 2.2.

3 Solder ability

Submerge the device terminals into the solder bath at 245℃ ±5℃ for 5s, More than 95% area of the soldering pad must be covered with new solder. It shall meet the specifications in 2.2

4 The Temperature Storage:

4.1 High Temperature Storage: The components shall remain within the electrical specifications after being kept at the 85℃±2℃ for 500h, recovery time : 2h±0.5h.

4.2 Low Temperature Storage: The components shall remain within the electrical specifications after being kept at the -40℃±3℃ for 500h, recovery time : 2h±0.5h.

5 Humidity test:

The components shall remain within the electrical specifications after being kept at the condition of ambient temperature 60℃±2℃, and 90~96% RH for 500h.

6 Mechanical shock

Drop the device randomly onto the concrete floor from the height of 1m for 3 times. The resonator shall fulfill the specifications in 2.2.

7 Vibration

Subject the device to the vibration for 2 hour each in X, Y and Z axes with the amplitude of 1.5 mm at 10 to 55 Hz. The resonator shall fulfill the specifications in 2.2.

※ Remark

1 Static voltage

Static voltage between signal load & ground may cause deterioration & destruction of the component. Please avoid static voltage.

2 Ultrasonic cleaning

Ultrasonic vibration may cause deterioration & destruction of the component. Please avoid ultrasonic cleaning

3 Soldering

Only leads of component may be soldered. Please avoid soldering another part of component.