



SPECIFICATION FOR APPROVAL

CUSTOMER : _____

PRODUCT TYPE : SMD GLASS SEALING X'TAL 3.2*2.5

NOMINAL FREQ. : 12.000000MHz

TXC P/N : 7V12000001

REVISION : S3

CUSTOMER P/N : _____

PM / SALES : _____

DATE : _____

CUSTOMER SIGNATURE & Date

- (1) TXC requires one copy returned with signature and title of authorized individual that signifies acceptance of the attached specifications.
- (2) Orders received and accepted by TXC after return of signed copy of specification will be produced per these specifications.
- (3) Any changes to these specifications must be agreed upon by both parties and new revision of the Product Specification Sheet will be issued.
- (4) Any issuance of purchase order prior to consigning back the Approval page of "Specification Sheets" from customers will be regarded as the agreement on the contents of these specifications.

Attachment: Product Specification Sheet

1

2

3

4

5

RoHS Compliant



PRODUCT SPECIFICATION SHEET

PRODUCT TYPE : SMD GLASS SEALING X'TAL 3.2*2.5

NOMINAL FREQ. : 12.000000MHz

TXC P/N : 7V12000001

REVISION : S3

PE/RD	QA	MFG
<i>Jake Lin</i>		
<i>15-Jul-08</i>		

NOTE:

- (1)Lead Free Products are "Directive 2002/95/EC of The European Parliament of 27 January 2003 on the restriction of the use of certain hazardous substances (RoHS) in electrical and electronic equipment" Compliant (Attachment: SGS Test Report).
- (2)Revision "Sx" is for engineering samples only. PE/RD's approval required.
- (3)Revision "Ax" is production ready. PE, QA and MFG's approval required.

RoHS Compliant

ELECTRICAL SPECIFICATIONS

Standard atmospheric conditions

Unless otherwise specified, the standard range of atmospheric conditions for making measurement and tests are as follow:

- Ambient temperature : 25±5℃
- Relative humidity : 40%~70%

If there is any doubt about the results, measurement shall be made within the following limits:

- Ambient temperature : 25±3℃
- Relative humidity : 40%~70%

Measure equipment

Electrical characteristics measured by HP E5100A or equivalent.

Crystal cutting type

The crystal is using AT CUT (thickness shear mode).

Unit Weight:

0.018±0.001 g/pcs

	Parameters	SYM.	Electrical Spec.				Notes
			MIN	TYPE	MAX	UNITS	
1	Nominal Frequency	FL	12.000000			MHz	-
2	Oscillation Mode	-	Fundamental			-	-
3	Load Capacitance	CL	18			pF	-
4	Frequency Tolerance	-	±20			ppm	at 25 °C ± 3 °C
5	Frequency Tolerance	-	±20			ppm	Over Operating Temp. Range (Reference 25°C)
6	Operating Temperature	-	-20	~	70	°C	-
7	Aging	-	±5			ppm	1st Year
8	Drive Level	DL	-	10	-	uW	-
9	Series Resonant Resistance	Rr	-	-	200	Ω	-
10	Shunt Capacitance	C0	-	-	5	pF	-
11	Insulation Resistance	-	500	-	-	MΩ	at DC 100V
12	Storage Temperature Range	-	-40	~	85	°C	-

■ DIMENSIONS

UNIT:mm

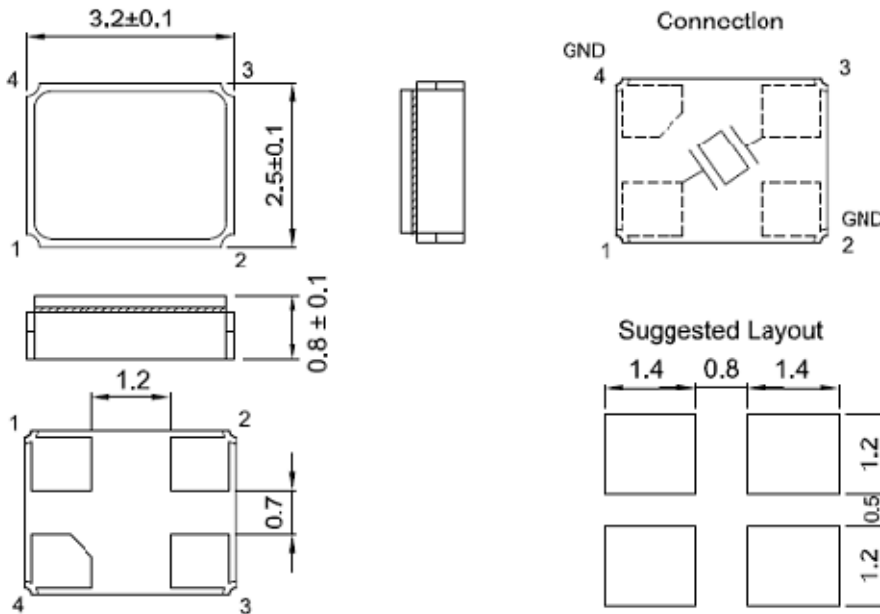

■ MARKING

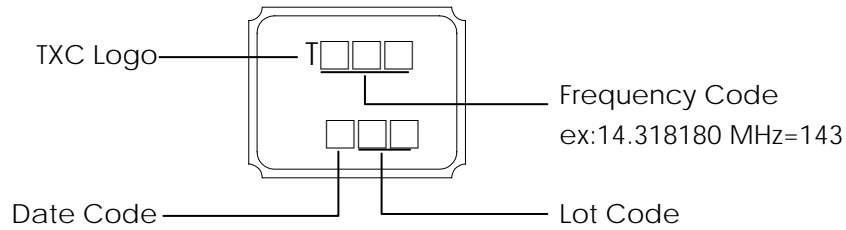

Date Code

YEAR					MONTH											
					JAN	FEB	MAR	APR	MAY	JUN	JUL	AUG	SEP	OCT	NOV	DEC
2001	2005	2009	2013	2017	A	B	C	D	E	F	G	H	J	K	L	M
2002	2006	2010	2014	2018	N	P	Q	R	S	T	U	V	W	X	Y	Z
2003	2007	2011	2015	2019	a	b	c	d	e	f	g	h	j	k	l	m
2004	2008	2012	2016	2020	n	p	q	r	s	t	u	v	w	x	y	z

This date code will be cycled every four years

■ SUGGESTED REFLOW PROFILE

Total time : 200 sec. Max.
Solder melting point :220 °C

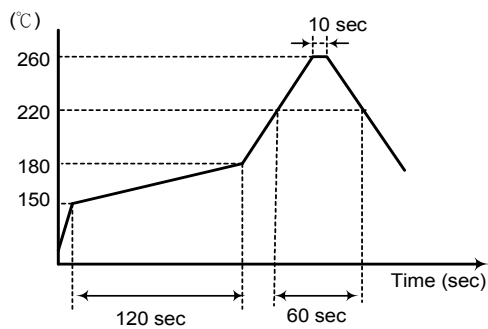

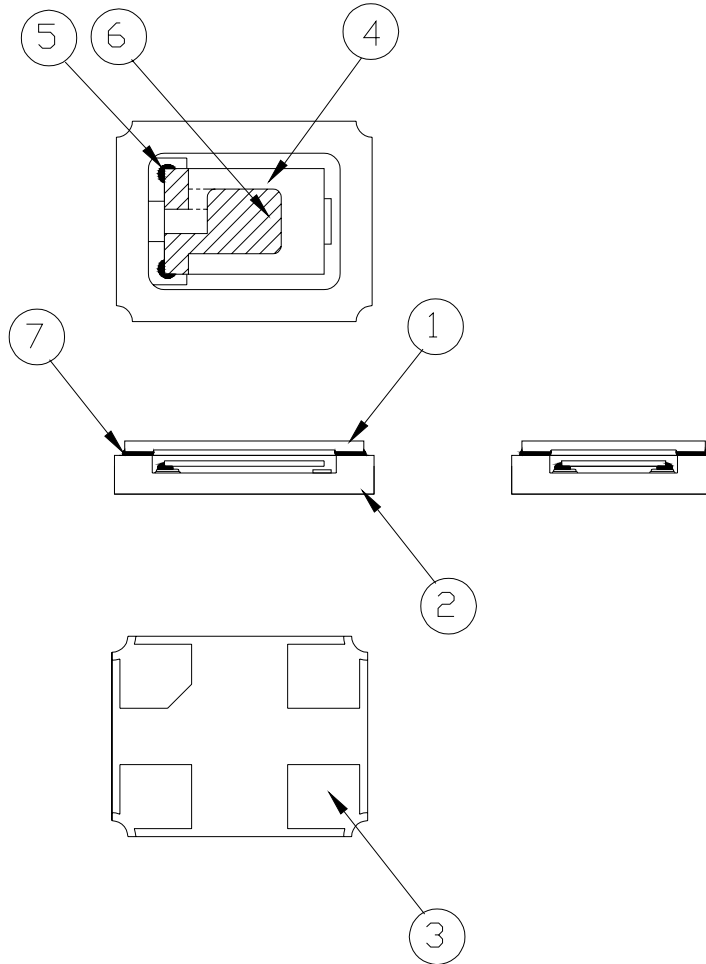
■ STRUCTURE ILLUSTRATION

NO	COMPONENTS	MATERIALS	QTY	FINISH/SPECIFICATIONS
1	Cap	Ceramic	1	Color black
2	Base	Ceramic	1	Color black
3	PAD	Au	4	Tungsten metalize + Ni plating + Au plating
4	Crystal blank	SiO ₂	1	-
5	Conductive adhesive	Ag	4	Silicon resin
6	Electrode	Ag + Cr	2	-
7	Glass	-	-	-

■ PACKING : (EIA-481-2)

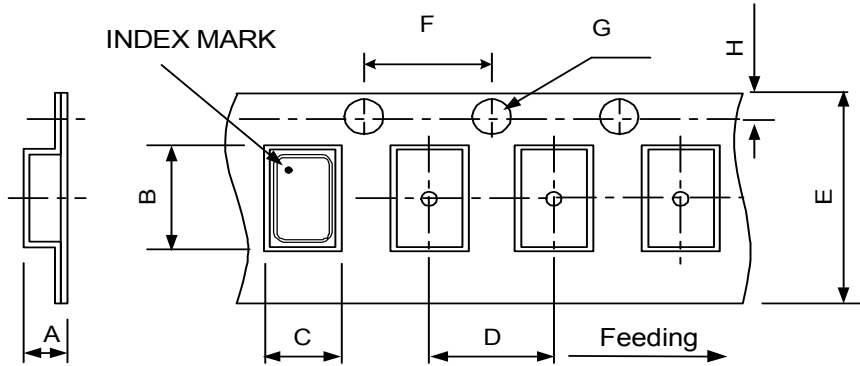

DIMENSIONS	A	B	C	D	E	F	G	H	(UNIT : mm)
	1.40	3.40	2.70	4.00	8.00	4.00	1.50	1.75	

REMARK :

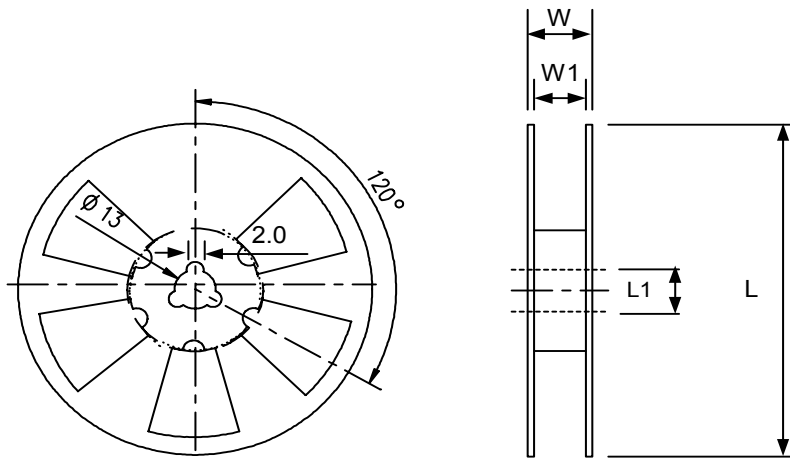
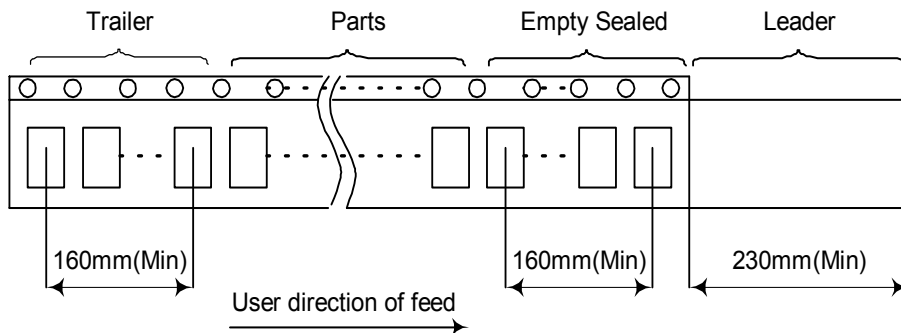

DIMENSIONS	L	L1	W	W1	pcs / Reel (UNIT : mm)
	178	13	11.5	8	Standard Reel Quantity is 3,000 pcs per reel

RELIABILITY SPECIFICATIONS

1. Mechanical Endurance

No.	Test Item	Test Methods	CRITIREA	REF.DOC
1.1	Drop Test	100 cm height, 10 times on concrete floor.	$\Delta F/F < +/- 5\text{ppm}$ $\Delta Cl < +/- 5 \text{ Ohm}$	JIS C6701
1.2	Mechanical Shock	Device are shocked to half sine wave (1000 G) three mutually perpendicular axes each 3 times. 0.5m sec. duration time	$\Delta F/F < +/- 5\text{ppm}$ $\Delta Cl < +/- 5 \text{ Ohm}$	MIL-STD-202F
1.3	Vibration	Frequency range 10 ~ 2000 Hz Amplitude 1.52 mm/20G Sweep time 20 minute Perpendicular axes each test time 4 hours (Total test time 12 hours)	$\Delta F/F < +/- 5\text{ppm}$ $\Delta Cl < +/- 5 \text{ Ohm}$	MIL-STD-883E
1.4	Solder ability	Temperature 240 °C ± 5°C Immersing depth 0.5 mm minimum Immersion time 5 ± 1 seconds Flux Rosin resin methyl alcohol solvent (1 : 4)	Check by Microscope At Least 95% Coated	MIL-STD-883E

2. Environmental Endurance

No.	Test Item	Test Methods	CRITIREA	REF. DOC
2.1	Resistance To Soldering Heat	Pre-heat temperature 125 °C Pre-heat time 60 ~ 120 sec. Test temperature 260 ± 5 °C Test time 10 ± 1 sec. Times 3	$\Delta F/F < +/- 5\text{ppm}$ $\Delta Cl < +/- 5 \text{ Ohm}$	MIL-STD-202F
2.2	High Temp. Storage	+ 125 °C ± 3 °C for 500 ± 12 hours	$\Delta F/F < +/- 5\text{ppm}$ $\Delta Cl < +/- 5 \text{ Ohm}$	MIL-STD-883E
2.3	Low Temp. Storage	- 40 °C ± 3 °C for 500 ± 12 hours	$\Delta F/F < +/- 5\text{ppm}$ $\Delta Cl < +/- 5 \text{ Ohm}$	
2.4	Thermal Shock	Total 100 cycles of the following temperature cycle 	$\Delta F/F < +/- 5\text{ppm}$ $\Delta Cl < +/- 5 \text{ Ohm}$	MIL-STD-883E
2.5	High Temp & Humidity	85°C ± 3°C, RH 85% , 500Hrs	$\Delta F/F < +/- 5\text{ppm}$ $\Delta Cl < +/- 5 \text{ Ohm}$	JIS C5023